

**APL**  
ARCHITECTURAL PROFILES

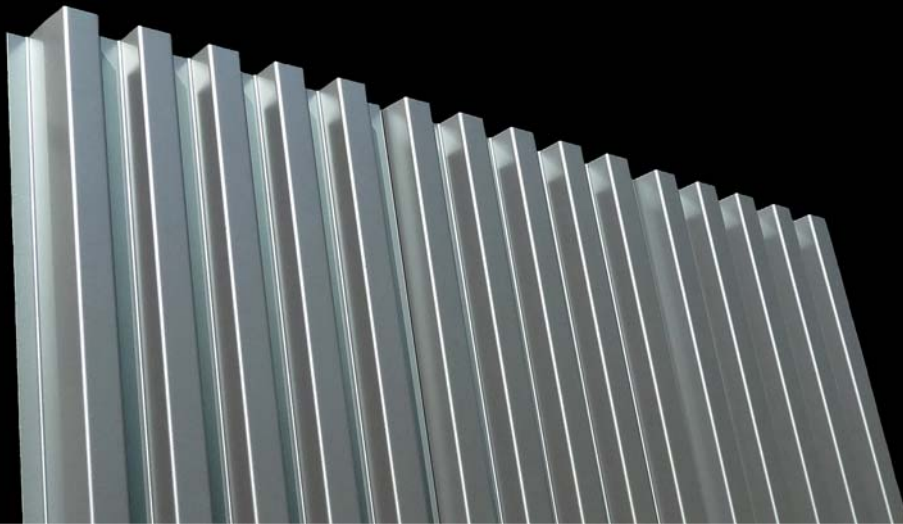

APL Custom Bespoke Panels & Profiles





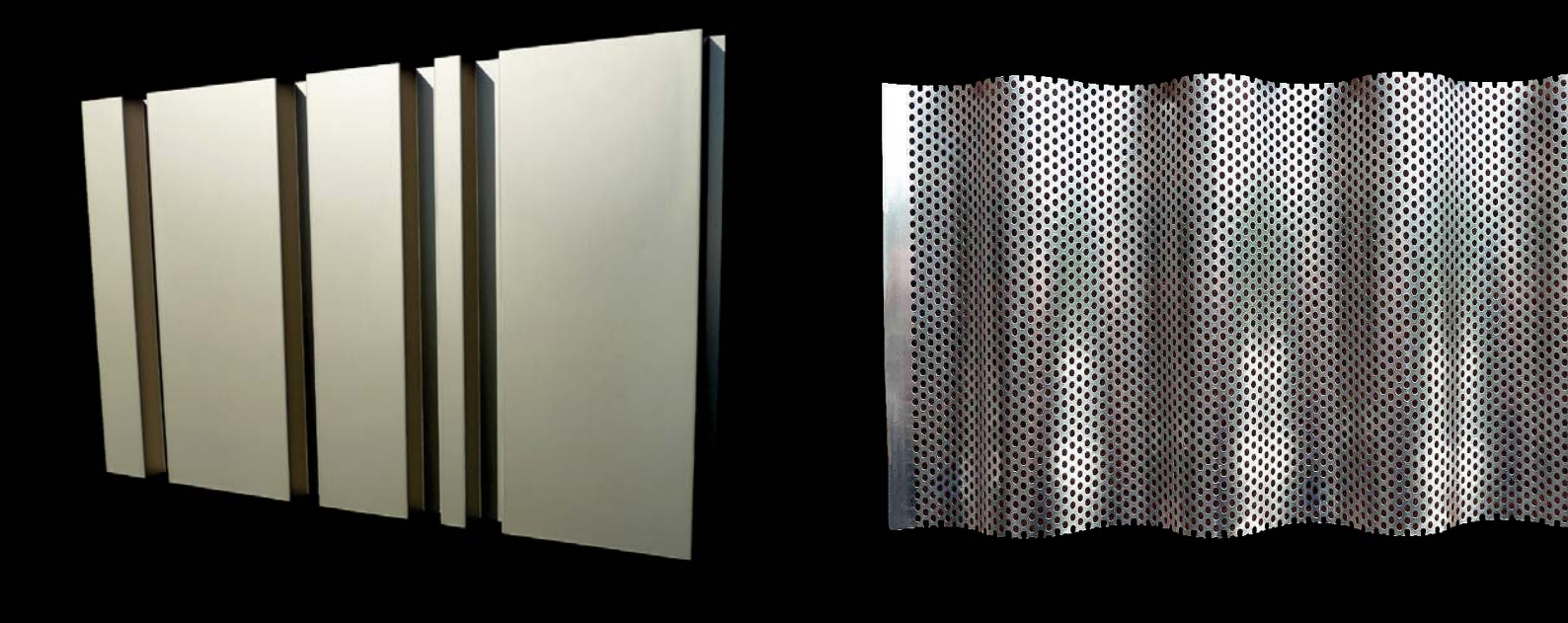

## APL Custom Bespoke Panels & Profiles

Our Custom profiles allow designers to choose their required colour, shape, finish and dimensions to deliver a result not achievable with standard roll-formed product

- The size and shape of the profiles can be changed
  - The pitch of the profiles can be changed
  - The depth of the profiles can be changed

Designs can even match brick modules between window openings to provide a uniform and consistent panel fit

Custom profiles are available in either aluminium or steel. Finishes include pre-painted coatings, powder coating, anodised aluminium, and Corten steel. Depending upon the finish, colour choice is almost infinite!

For a truly bespoke facade choose the APL 'Bespoke' service.

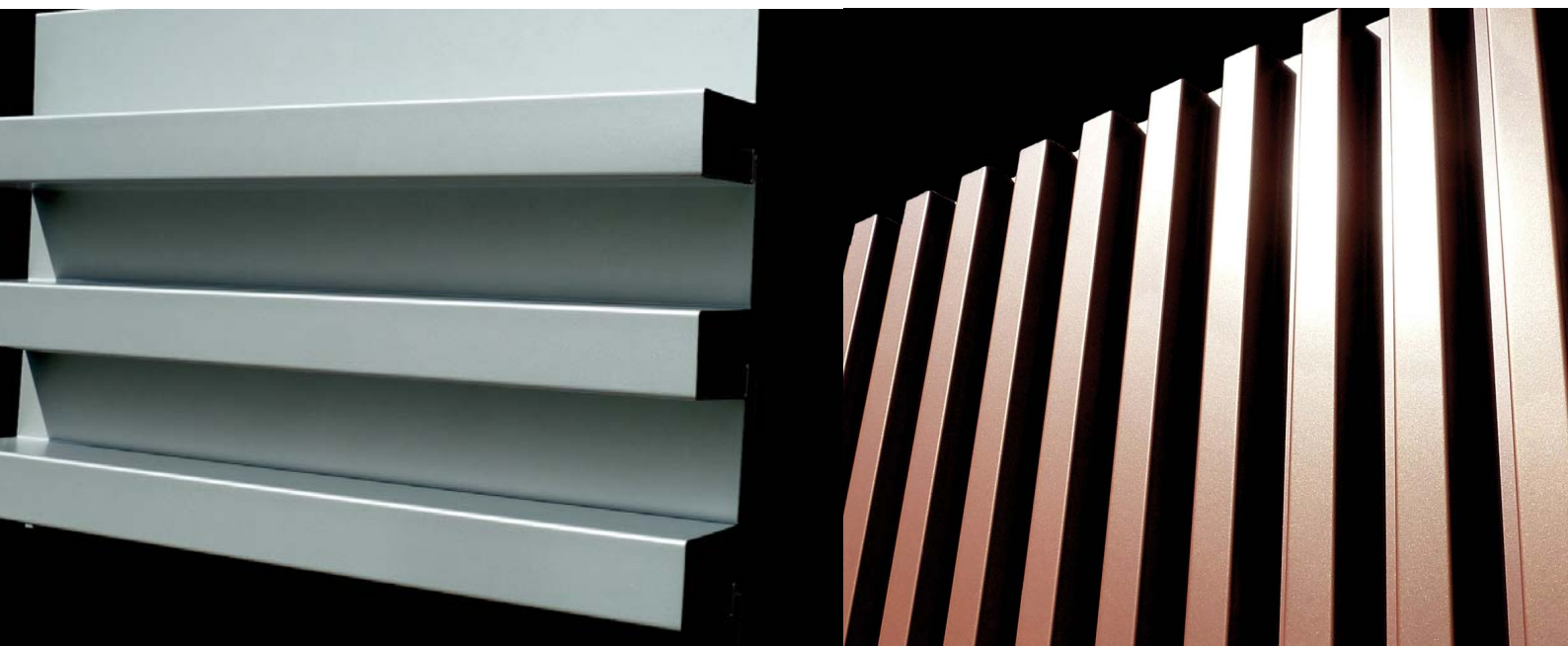

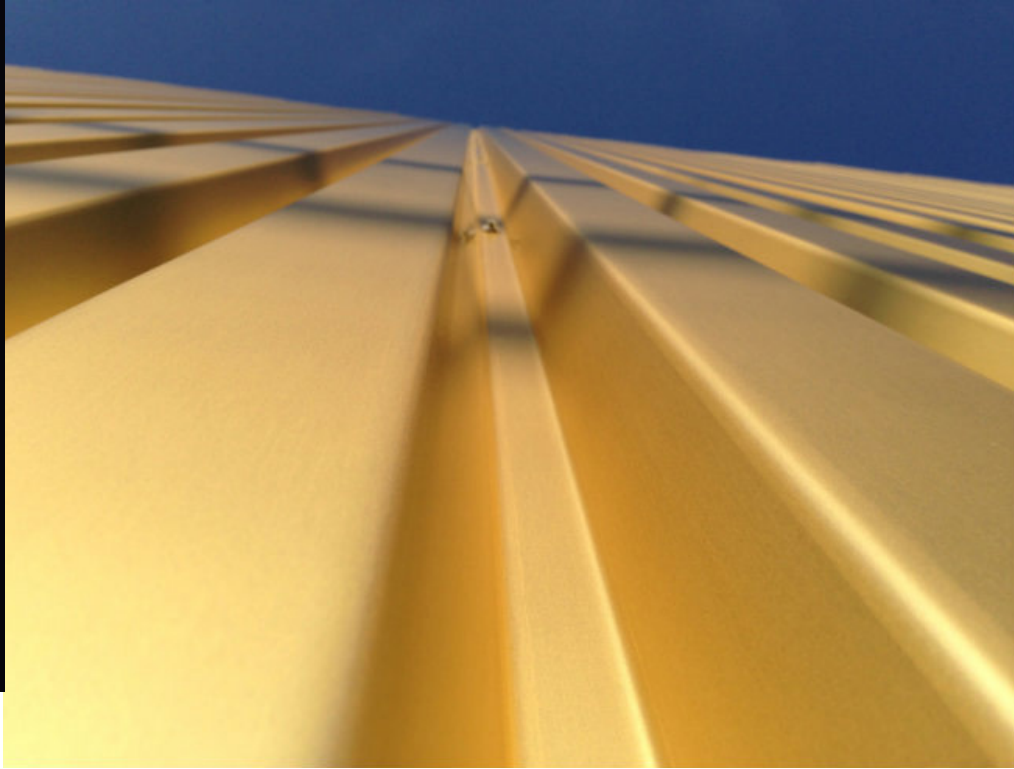
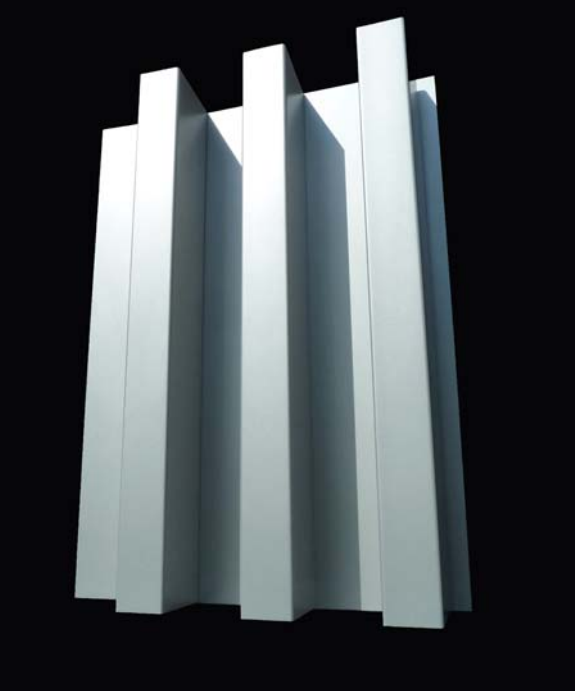

- Variety of installation methods – secret fix, surface fix, portrait, landscape
- Lengths upto 6m
- Available in aluminium and steel
- Available in mill finish aluminium, stucco embossed aluminium, PPC, Armacoil™ (2-layer PVDF coating system), ArmacoilPLUS™ (3-layer PVDF coating system), Anodised, PUF, PRISMA and LG finishes
- Can be installed on to all structures – including the extremely popular StrongBak™ system
- Compatible with a variety of carrier systems – including the highly energy efficient and economical Tritherm™ system

#### Typical Bespoke Vertical Assembly

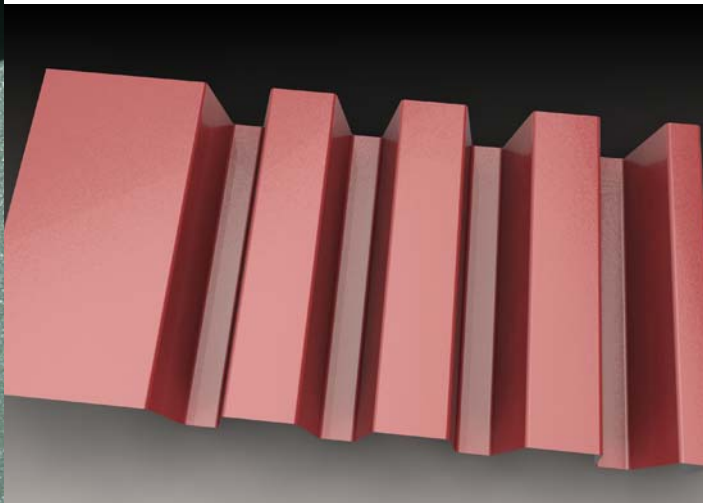
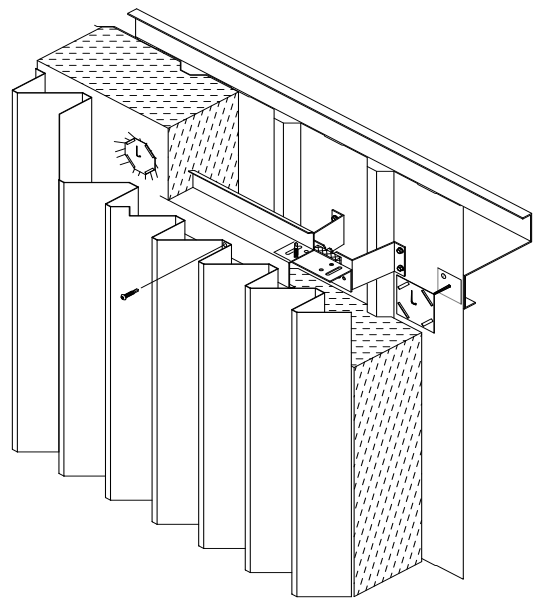



# Who are Architectural Profiles?



- Specialists in complete NON-COMBUSTIBLE “through-wall” and “through-roof” systems
- Established for over 35 years
- All systems and constructions fire-tested
- Specified by the UK’s leading architects
- Chosen by the UK’s leading contractors and installers
- Provider of Cladshield - a 25-year fully-installed system warranty
- 55,000 sqft UK manufacturing facility
- Established members of the MCRMA & CWCT
- ISO:9001 & ISO:14001 registered

CUSTOM BESPOKE PANELS & PROFILES • STRONGBAK • LOUVRE PROFILE & LIVE LOUVRES •  
RAINSCREEN & FLAT PANELS • WALL & ROOF PROFILES • APL SNAPLOC  
STANDING SEAM • SOFFITS • ARCHITECTURAL FLASHINGS • DECKING



Non-combustible system



25 year fully installed system warranty



Official partner of  
ALUCOBOND

Tel: 0118 927 2424 | Email: [info@archprof.co.uk](mailto:info@archprof.co.uk) | [www.archprof.co.uk](http://www.archprof.co.uk)

Architectural Profiles Limited 53 Crockhamwell Road, Woodley, Reading, Berkshire, RG5 3JP

All systems and products are subject to change. Terms and Conditions available upon request. v3

Established  
35 years, all  
manufactured  
by us in the UK,  
and proud of it!

